



HEWLETT
PACKARD

OPERATING AND SERVICE MANUAL

MODEL 3575A GAIN-PHASE METER

Serial Number: 1450A01646

IMPORTANT NOTICE

This loose-leaf manual does not require a change sheet. All change information has been integrated into the manual by means of revised pages. Each revised page is identified by a revision letter located at the bottom of the page. A reference, located directly below the revision letter, indicates which of the backdating changes in Appendix C apply to that page. If the serial number of your instrument is lower than the one on this title page, the manual contains revisions that may not apply to your instrument. Refer to Appendix C for complete backdating information.

WARNING

To help minimize the possibility of electrical fire or shock hazards, do not expose this instrument to rain or excessive moisture.

Manual Part No. 03575-90002

Microfiche No. 03575-90053

©Copyright Hewlett-Packard Company 1972
P.O. Box 301, Loveland, Colorado 80537 U.S.A.

Printed: June 1976



**HEWLETT
PACKARD**

CERTIFICATION

Hewlett-Packard Company certifies that this product met its published specifications at the time of shipment from the factory. Hewlett-Packard further certifies that its calibration measurements are traceable to the United States National Bureau of Standards, to the extent allowed by the Bureau's calibration facility, and to the calibration facilities of other International Standards Organization members.

WARRANTY

This Hewlett-Packard product is warranted against defects in material and workmanship for a period of one year from date of shipment [except that in the case of certain components listed in Section I of this manual, the warranty shall be for the specified period]. During the warranty period, Hewlett-Packard Company will, at its option, either repair or replace products which prove to be defective.

For warranty service or repair, this product must be returned to a service facility designated by -hp-. Buyer shall prepay shipping charges to -hp- and -hp- shall pay shipping charges to return the product to Buyer. However, Buyer shall pay all shipping charges, duties, and taxes for products returned to -hp- from another country.

Hewlett-Packard warrants that its software and firmware designated by -hp- for use with an instrument will execute its programming instructions when properly installed on that instrument. Hewlett-Packard does not warrant that the operation of the instrument, or software, or firmware will be uninterrupted or error free.

LIMITATION OF WARRANTY

The foregoing warranty shall not apply to defects resulting from improper or inadequate maintenance by Buyer, Buyer-supplied software or interfacing, unauthorized modification or misuse, operation outside of the environmental specifications for the product, or improper site preparation or maintenance.

NO OTHER WARRANTY IS EXPRESSED OR IMPLIED. HEWLETT-PACKARD SPECIFICALLY DISCLAIMS THE IMPLIED WARRANTIES OF MERCHANTABILITY AND FITNESS FOR A PARTICULAR PURPOSE.

EXCLUSIVE REMEDIES

THE REMEDIES PROVIDED HEREIN ARE BUYER'S SOLE AND EXCLUSIVE REMEDIES. HEWLETT-PACKARD SHALL NOT BE LIABLE FOR ANY DIRECT, INDIRECT, SPECIAL, INCIDENTAL, OR CONSEQUENTIAL DAMAGES, WHETHER BASED ON CONTRACT, TORT, OR ANY OTHER LEGAL THEORY.

ASSISTANCE

Product maintenance agreements and other customer assistance agreements are available for Hewlett-Packard products.

For any assistance, contact your nearest Hewlett-Packard Sales and Service Office. Addresses are provided at the back of this manual.



**HEWLETT
PACKARD**

SAFETY SUMMARY

The following general safety precautions must be observed during all phases of operation, service, and repair of this instrument. Failure to comply with these precautions or with specific warnings elsewhere in this manual violates safety standards of design, manufacture, and intended use of the instrument. Hewlett-Packard Company assumes no liability for the customer's failure to comply with these requirements. This is a Safety Class 1 instrument.

GROUND THE INSTRUMENT

To minimize shock hazard, the instrument chassis and cabinet must be connected to an electrical ground. The instrument is equipped with a three-conductor ac power cable. The power cable must either be plugged into an approved three-contact electrical outlet or used with a three-contact to two-contact adapter with the grounding wire (green) firmly connected to an electrical ground (safety ground) at the power outlet. The power jack and mating plug of the power cable meet International Electrotechnical Commission (IEC) safety standards.

DO NOT OPERATE IN AN EXPLOSIVE ATMOSPHERE

Do not operate the instrument in the presence of flammable gases or fumes. Operation of any electrical instrument in such an environment constitutes a definite safety hazard.

KEEP AWAY FROM LIVE CIRCUITS

Operating personnel must not remove instrument covers. Component replacement and internal adjustments must be made by qualified maintenance personnel. Do not replace components with power cable connected. Under certain conditions, dangerous voltages may exist even with the power cable removed. To avoid injuries, always disconnect power and discharge circuits before touching them.

DO NOT SERVICE OR ADJUST ALONE

Do not attempt internal service or adjustment unless another person, capable of rendering first aid and resuscitation, is present.

DO NOT SUBSTITUTE PARTS OR MODIFY INSTRUMENT

Because of the danger of introducing additional hazards, do not install substitute parts or perform any unauthorized modification to the instrument. Return the instrument to a Hewlett-Packard Sales and Service Office for service and repair to ensure that safety features are maintained.

DANGEROUS PROCEDURE WARNINGS

Warnings, such as the example below, precede potentially dangerous procedures throughout this manual. Instructions contained in the warnings must be followed.

WARNING

Dangerous voltages, capable of causing death, are present in this instrument. Use extreme caution when handling, testing, and adjusting.

SAFETY SYMBOLS

General Definitions of Safety Symbols Used On Equipment or In Manuals.



Instruction manual symbol: the product will be marked with this symbol when it is necessary for the user to refer to the instruction manual in order to protect against damage to the instrument.



Indicates dangerous voltage (terminals fed from the interior by voltage exceeding 1000 volts must be so marked).

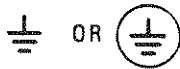

Protective conductor terminal. For protection against electrical shock in case of a fault. Used with field wiring terminals to indicate the terminal which must be connected to ground before operating equipment.



Low-noise or noiseless, clean ground (earth) terminal. Used for a signal common, as well as providing protection against electrical shock in case of a fault. A terminal marked with this symbol must be connected to ground in the manner described in the installation (operating) manual, and before operating the equipment.

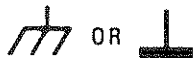

Frame or chassis terminal. A connection to the frame (chassis) of the equipment which normally includes all exposed metal structures.



Alternating current (power line).



Direct current (power line).



Alternating or direct current (power line).

WARNING

The **WARNING** sign denotes a hazard. It calls attention to a procedure, practice, condition or the like, which, if not correctly performed or adhered to, could result in injury or death to personnel.

CAUTION

The **CAUTION** sign denotes a hazard. It calls attention to an operating procedure, practice, condition or the like, which, if not correctly performed or adhered to, could result in damage to or destruction of part or all of the product.

NOTE :

The **NOTE** sign denotes important information. It calls attention to procedure, practice, condition or the like, which is essential to highlight.

SECTION I

GENERAL INFORMATION

1-1. DESCRIPTION.

1-2. The Hewlett-Packard Model 3575A Gain-Phase Meter is a versatile, wide-range ac voltage analyzer which affords direct, convenient measurement of amplitude and phase parameters. The major features of the instrument include broadband frequency response, wide dynamic range, digital readout plus a unique detection scheme which ensures accurate phase measurements in the presence of noise and distortion. These standard features, along with a variety of options including dual panel meters, BCD output and remote control, make the 3575A a truly flexible instrument that is well suited for bench or systems applications.

1-3. The broadband frequency response of the Model 3575A extends from 1 Hz to 13 MHz in four overlapping frequency ranges. For maximum operating convenience, each range is designed to cover a wide band of frequencies while range selectability allows the user to optimize measurement accuracy and settling time over the entire frequency spectrum.

1-4. The 3575A is equipped with two independent input channels. Each channel provides an 80 dB dynamic range which allows "hands off" operation with a wide range of input levels. In addition, each channel is equipped with a 20 dB input attenuator which provides an extended operating capability of 100 dB in two voltage ranges. Input sensitivity is from 0.2 mV rms to 2 V rms on the lower range and 2 mV rms to 20 V rms on the higher range. The 1 Megohm $<$ 30 pF input impedance of each channel permits the use of 10:1 divider probes which further extend the maximum input level to 200 V rms and the overall operating range to 120 dB.

1-5. The 3575A contains a built-in dc digital voltmeter which provides a direct indication of amplitude or phase on a 3 1/2 digit (LED) display. Lighted annunciators on the panel meter indicate dB V, dB or degrees depending on the parameter being measured. The panel meter display is determined by the front panel Display switch which permits selection of Amplitude or Phase presentation. For recording purposes, an Analog Output (BNC) connector is provided on the rear panel of the instrument. The Analog Output supplies a dc voltage proportional to the panel meter reading.

1-6. When Amplitude Display is selected, the panel meter presentation is controlled by the front panel Amplitude Function switch which permits selection of three different functions. These functions are Log A, Log B and Log B/A. When Log A or Log B is selected, the panel meter indicates the logarithmic amplitude of the respective input signal in

dBV (1 V rms = 0 dBV). Input levels from 0.2 mV rms (-74 dBV) to 20 V rms (+26 dBV) can be measured with 0.1 dBV resolution in two voltage ranges. When Log B/A is selected, the panel meter indicates the relative amplitude of the two input signals in dB. The display range for relative measurements is from -100 dB to +100 dB with 0.1 dB resolution. Since the two input channels each contain ac/dc converters and are totally independent, relative measurements can be made between two signals that differ in frequency.

1-7. The 3575A amplitude functions are particularly useful for measuring gain, attenuation and other characteristics where amplitude comparison is required. The Log B/A function eliminates the need for separate input and output measurements and time consuming difference calculations.

1-8. When Phase Display is selected, the 3575A measures the phase difference between two input signals. The phase measurement range is from -180 degrees to +180 degrees with 12 degrees overrange and 0.1 degree display resolution. Due to the wide dynamic range of the instrument, phase difference can be measured between two signals that differ in amplitude by as much as 100 dB.

1-9. An accurate phase meter is of little value unless the accuracy can be maintained in the presence of noise and distortion. Unlike conventional phase meters, the 3575A uses two phase detectors rather than a single phase detector. This, in conjunction with a highly effective error correction scheme, greatly reduces the effects of noise and distortion on phase readings.

1-10. SPECIFICATIONS.

1-11. Table 1-1 is a complete list of the Model 3575A critical specifications that are controlled by tolerances. Table 1-2 contains general information that describes the operating characteristics of the Model 3575A.

1-12. Any changes in specifications due to manufacturing, design, or traceability to the U.S. National Bureau of Standards are included in Table 1-1 in this manual. Specifications listed in this manual supersede all previous specifications for the Model 3575A.

1-13. OPTIONS.

1-14. There are presently three instrument and two accessory options available for the Model 3575A. These options are as follows:

Option	Factory Installed*
Dual Panel Meters	Option 001
Dual Panel Meters, BCD Outputs and Remote Control	Option 002, 003**
Kit, Rack Mount	Option 908
Additional Manual	Option 910

* Field installable option kits are available.

** Options 002 and 003 are identical except for assertion states of BCD outputs (see Table 1-2).

Table 1-2. General Information.

INPUTS	DISPLAY MODES																				
<p>Front Panel Inputs: Female BNC connectors</p> <p>Input Impedance: 1 Megohm (nominal) shunted by < 30 pF</p> <p>Rear Panel Inputs: Holes are provided on the rear panel for installing BNC input connectors in place of the front panel input connectors. When rear-panel inputs are used, the shunt capacitance increases to approximately 40 pF (not compatible with 10:1 divider probes).</p>	<p>Amplitude or Phase (front panel DISPLAY switch)</p>																				
<p>ANALOG OUTPUTS</p> <p>Connectors: Female BNC connectors, labeled ANALOG OUTPUT 1 and ANALOG OUTPUT 2 are located on the rear panel of the instrument. Analog Output 2 is used only in instruments equipped with dual panel meters (Options 001 and 002).</p> <p>Resistance: 1 Kilohm (nominal)</p> <p>Output Voltage:</p> <p>Amplitude Measurements: 10 mVdc per dB/dBV with > 2 Megohm load resistance. Phase Measurements: 10 mVdc per degree with > 2 Megohm load resistance.</p>	<p>AMPLITUDE MEASUREMENTS</p> <p>Amplitude Functions: A dBV, B dBV, or B/A (front panel AMPLITUDE FUNCTION switch)</p> <p>Display Range (A dBV, B dBV): -74.0 dBV to +26.0 dBV (in two Voltage Ranges)</p> <p>Display Range (B/A): -100.0 dB to +100.0 dB*</p> <p>* Both input signals must be within the range of 0.2 mV rms to 20 V rms.</p> <p>Display Resolution: 0.1 dBV, 0.1 dB</p> <p>Amplitude Reference (A dBV, B dBV): 1 V rms = 0 dBV</p> <p>Reference Channel (B/A): Channel A*</p> <p>* A negative reading means that the signal applied to Channel B is lower in amplitude than the signal applied to channel A; a positive reading means that the signal applied to Channel B is greater in amplitude than the signal applied to Channel A.</p>																				
<p>RESPONSE TIME</p> <p>Typical Settling Time: (following a change in input parameters):</p> <table border="1" style="width: 100%;"> <thead> <tr> <th>Frequency Range</th> <th>100 % * Settled</th> <th>95 % * Settled</th> <th>90 % * Settled</th> </tr> </thead> <tbody> <tr> <td>1 Hz - 1 kHz</td> <td>30 sec.</td> <td>20 sec.</td> <td>17 sec.</td> </tr> <tr> <td>10 Hz - 100 kHz</td> <td>3 sec.</td> <td>2 sec.</td> <td>1.7 sec.</td> </tr> <tr> <td>100 Hz - 1 MHz</td> <td>0.3 sec.</td> <td>0.2 sec.</td> <td>0.17 sec.</td> </tr> <tr> <td>1 kHz - 13 MHz</td> <td>30 ms.</td> <td>20 ms.</td> <td>17 ms.</td> </tr> </tbody> </table> <p>* Percent of final reading</p>	Frequency Range	100 % * Settled	95 % * Settled	90 % * Settled	1 Hz - 1 kHz	30 sec.	20 sec.	17 sec.	10 Hz - 100 kHz	3 sec.	2 sec.	1.7 sec.	100 Hz - 1 MHz	0.3 sec.	0.2 sec.	0.17 sec.	1 kHz - 13 MHz	30 ms.	20 ms.	17 ms.	<p>PHASE MEASUREMENTS</p> <p>Phase Measurement Range: -180 degrees to +180 degrees with 12 degrees overrange</p> <p>Display Resolution: 0.1 degree</p> <p>Phase Reference: A or -A (front PHASE REFERENCE switch)*</p> <p>*1) Channel A is the reference channel. A negative reading means that B lags A; a positive reading means that B leads A.</p> <p>*2) With the Phase Reference set to -A, Channel A is inverted and the phase reading is offset by 180 degrees.</p>
Frequency Range	100 % * Settled	95 % * Settled	90 % * Settled																		
1 Hz - 1 kHz	30 sec.	20 sec.	17 sec.																		
10 Hz - 100 kHz	3 sec.	2 sec.	1.7 sec.																		
100 Hz - 1 MHz	0.3 sec.	0.2 sec.	0.17 sec.																		
1 kHz - 13 MHz	30 ms.	20 ms.	17 ms.																		
<p>RANGES</p> <p>Frequency Range: 1 Hz to 13 MHz in four ranges:</p> <p>1 Hz to 1 kHz 10 Hz to 100 kHz 100 Hz to 1 MHz 1 kHz to 13 MHz</p> <p>Dynamic Range: 80 dB</p> <p>Operating Range (Each Channel): 100 dB in two ranges:</p> <p>0.2 mV rms to 2 V rms (-74 dBV to +6 dBV) 2 mV rms to 20 V rms (-54 dBV to +26 dBV)</p>	<p>Error Introduced by Noise: < 2 degrees (nominal) for a 1 V rms 10 kHz sine wave and 1 MHz gaussian noise on one channel with 30 dB signal to noise ratio using the 100 Hz to 1 MHz Frequency Range.</p> <p>Error Introduced by Distortion:</p> <p>Even Harmonics: Cancelled - No Error Odd, In-Phase Harmonics: No Error Odd, Out-of-Phase Harmonics: < 0.6 degrees (nominal) when total odd harmonic distortion is more than 40 dB below the fundamental.</p>																				

Table 1-2. General Information (Cont'd).

DIGITAL READOUT

Display: 3 1/2 digits with fixed decimal indicator, polarity sign and annunciators.

Reading Rate (Internal Sampling): 4 readings per second

GENERAL

Operating Temperature Range: 0° C to +55° C, unless otherwise specified

Storage Temperature: -40° C to +75° C

Power Requirements: 115 V or 230 V ± 10 %, 48 Hz to 440 Hz, 50 VA, maximum.

Weight:

Net Weight: 18 1/4 lbs.
Shipping Weight: 25 lbs.

Dimensions:

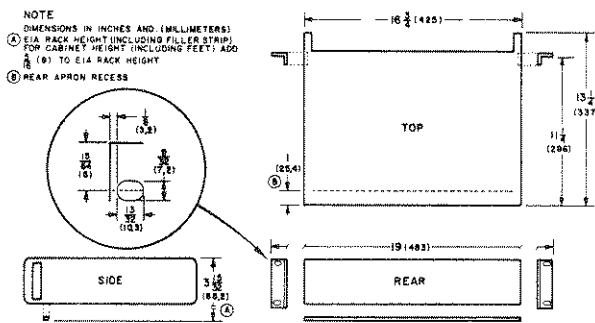

OPTIONS

Dual Panel Meters (Option 001): The 3575A Option 001 is equipped with dual panel meters and dual analog outputs for simultaneous amplitude and phase presentations.

Left-Hand Panel Meter: Indicates A dBV, B dBV or B/A as determined by the Amplitude Function switch setting.

Right-Hand Panel Meter: Indicates B dBV or phase as determined by the Amplitude B/Phase switch setting.

Dual Analog Outputs: Rear panel BNC connectors provide dc output voltages that correspond with the respective panel meter readings (also see Analog Output heading).

Dual Panel Meters, BCD Output and Remote Control (Options 002, 003): The 3575A Options 002, and 003 are equipped with dual panel meters and dual analog outputs (same as Option 001) plus dual BCD outputs and a complete remote control capability.

Remote Logic: The 3575A Option 002 uses Low True TTL logic for BCD outputs and remote control lines. The 3575A Option 003 uses High True TTL logic for BCD Outputs and Low True TTL logic for remote control lines.

State	BCD Outputs *	Remote Control Lines
"0"	+ 2.4 V to + 5 V	Open or + 2.4 V to + 5 V
"1"	0 V to + 0.4 V	Gnd. or - 0.5 V to + 0.4 V

* In 3575A Option 003, BCD Outputs are High True.

BCD Outputs: Provide parallel binary-coded data that corresponds with the respective panel meter reading. Fourteen lines for each panel meter include three 8-4-2-1 BCD-coded digits, a single line overrange ("1'") digit and a single line polarity indicator.

Overload Outputs: Three output lines, A_{OL}, B_{OL} and "overload", indicate overload on A, overload on B and overload on A OR B.

Remote Control Lines: Eight input lines accept parallel binary instructions for remote control of all front panel functions, ranges and settings (except LINE ON/OFF). Internal storage is not provided.

Control Modes: Local or Remote (1 control line)

Remote Measure: 1 control line*

* In the Remote Control mode, the panel meters must be externally triggered by applying a ground-true momentary pulse (> 1 ms) to the Remote Measure line each time a reading is required. The Remote Measure command should not be applied for at least 0.5 ms following any change that affects the programmed state of the instrument.

Isolation: Remote input and output lines are *not* isolated.

Trigger Mode: Delayed or Non-Delayed (1 control line)*

* The trigger mode determines the time required to obtain panel meter readings or BCD outputs initiated by the Remote Measure command. In the Delayed mode the time is variable and is controlled by the Frequency Range setting:

Frequency Range	Delay Time (nominal)
1 Hz to 1 kHz	33 seconds
10 Hz to 100 kHz	4 seconds
100 Hz to 1 MHz	1.1 seconds
1 kHz to 13 MHz	0.66 seconds

In the Non-Delayed mode, the measurement time is fixed at 600 ms regardless of the Frequency Range setting.

Data Flags: + Data Flag and - Data Flag (2 output lines)*

* Provide a "Data Ready" indication to the external controller. Flags are "set" by the Remote Measure pulse and "reset" at the end of the delay (Trigger Mode) cycle.

Condition	Indication	+ Data Flag	- Data Flag
"Set"	Data Not Ready	1	0
"Reset"	Data Ready	0	1

1-15. For further information concerning these options, refer to Table 1-2 (General Information) or Section III in this manual or contact the nearest -hp- Sales and Service Office.

1-16. ACCESSORIES SUPPLIED.

1-17. Table 1-3 is a list of accessories supplied with the Model 3575A.

1-18. ACCESSORIES AVAILABLE.

1-19. Table 1-4 is a list of Hewlett-Packard accessories that are available for use with the Model 3575A.

1-20. INSTRUMENT AND MANUAL IDENTIFICATION.

1-21. Hewlett-Packard uses a two-section serial number. The first section (prefix) identifies a series of instruments. The last section (suffix) identifies a particular instrument within the series. If a letter is included with the serial number, it identifies the country in which the instrument was manufactured. If the serial number of your instrument is lower than the one on the title page of this manual, refer to Appendix C for backdating information that will adapt this manual to your instrument. All correspondence with Hewlett-Packard should include the complete serial number.

Table 1-3. Accessories Supplied.

Description	Quantity	-hp- Part No.
Interface Connector (Opt. 002, 003)	1 ea.	1251-0086
Accessory Kit Includes the following:	1 ea.	03575-84411
PC Board Extender (22 pin)	1 ea.	5060-5989
PC Board Extender (12 pin)	1 ea.	5060-5988
PC Board Extender (10 pin)	1 ea.	5060-5987

Table 1-4. Accessories Available.

-hp- Model	Description
10004A	Voltage Divider Probe (miniature)
456A	AC Current Probe
562A-16C	Printer Cable (for 5050A and 5055B Printers)
11048C	50 Ohm Feed-Thru Termination
11094B	75 Ohm Feed-Thru Termination
11095A	600 Ohm Feed-Thru Termination
5060-8739	Rack Mounting Kit

SECTION II

INSTALLATION AND INTERFACING

2-1. INTRODUCTION.

2-2. This section contains information and instructions necessary for installing, shipping and interfacing the Model 3575A Gain-Phase Meter. Included are initial inspection procedures, power and grounding requirements, environmental information, mounting instructions, instructions for repackaging for shipment and interfacing information for Option 002 and 003 instruments.

2-3. INITIAL INSPECTION.

2-4. This instrument was carefully inspected both mechanically and electrically before shipment. It should be physically free of marks or scratches and in perfect electrical order upon receipt. To confirm this, the instrument should be inspected for physical damage incurred in transit. If the instrument was damaged in transit, file a claim with the carrier. Check for supplied accessories (Table 1-3) and test the electrical performance of the instrument using the performance check procedures outlined in Section V. If there is damage or deficiency, see the warranty on the inside title page of this manual.

2-5. POWER REQUIREMENTS.

2-6. The Model 3575A can be operated from any source of 115 or 230 volts ($\pm 10\%$), 48 Hz to 440 Hz. Power dissipation is 50 VA; maximum.

2-7. Power Cords.

2-8. Figure 2-1 illustrates the standard power plug configurations that are used throughout the United States and in other countries. The -hp- part number shown directly below each plug drawing is the part number for a 3575A power cord equipped with the proper plug. If the appropriate power cord is not included with the instrument, notify the nearest Hewlett-Packard office and a replacement cord will be provided.

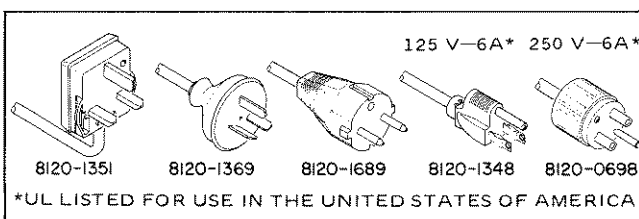

Figure 2-1. Power Cords.

2-9. GROUNDING REQUIREMENTS.

2-10. To protect operating personnel, the National Electrical Manufacturer's Association (NEMA) recommends that the instrument panel and cabinet be grounded. The Model 3575A is equipped with a three-conductor power cable which, when plugged into an appropriate receptacle, grounds the instrument. The offset pin on the power plug is the ground connection.

2-11. ENVIRONMENTAL REQUIREMENTS.

2-12. The Model 3575A is a low power, fully transistorized instrument; therefore, no special cooling arrangements are required. The 3575A should not be operated where the ambient temperature is below 0°C (32°F) or above 55°C (131°F) or where the relative humidity exceeds 95%. The instrument should not be stored where the ambient temperature is below -40°C (-40°F) or above 75°C (167°F).

2-13. INSTALLATION.

2-14. Bench Mounting.

2-15. The Model 3575A is shipped with plastic feet and tilt stand in place, ready for use as a bench instrument. The plastic feet are shaped so that the 3575A can be mounted on top of another Hewlett-Packard instrument.

2-16. Rack Mounting.

2-17. The Model 3575A can be rack mounted using the Rack Mounting Kit (-hp- 5060-8739) separately available as an accessory. Installation instructions are included with the kit. The rack mount for the Model 3575A is an EIA standard width of 19 inches.

2-18. REPACKAGING FOR SHIPMENT.

2-19. The following paragraphs contain a general guide for repackaging the instrument for shipment. Refer to Paragraph 2-20 if the original container is to be used; 2-21 if it is not. If you have any questions, contact the nearest -hp- Sales and Service Office (See Appendix B for office locations).

NOTE

If the instrument is to be shipped to Hewlett-Packard for service or repair, attach a tag to the instrument identifying the owner and indicating the service or repair to be accomplished. Include the model number and full serial number of the instrument. In any correspondence, identify the instrument by model number and full serial number.

2-20. Place instrument in original container with appropriate packing material and seal well with strong tape or metal bands. If original container is not available, one can be purchased from your nearest -hp- Sales and Service Office.

2-21. If original container is not to be used, proceed as follows:

a. Wrap instrument in heavy paper, or plastic before placing in an inner container.

b. Place packing material around all sides of instrument and protect panel face with cardboard strips.

c. Place instrument and inner container in a heavy carton or wooden box and seal with strong tape or metal bands.

d. Mark shipping container "DELICATE INSTRUMENT", "FRAGILE", etc.

2-22. INTERFACING (Options 002, 003 only).

NOTE

The 3575A Options 002 and 003 are identical except that Option 003 instruments use high-true logic for the BCD outputs. In all other respects, the following information for Option 002 instruments also applies to Option 003 instruments.

2-23. The 3575A Option 002 supplies BCD outputs that correspond with the panel meter readings and is equipped for remote control of all front panel functions, ranges and settings (except LINE ON/OFF). The remote input and output lines are available at the rear panel Interface connector, A19J1.

2-24. Figure 3-9 (Section III) illustrates the 3575A Option 002 Interface connector as viewed from the rear of the instrument. The connector drawing and the table within the figure provides complete input/output and control information. A 50-pin mating connector (-hp- 1251-0086*) and a 46-conductor cable are required to connect all input and output lines, circuit ground and +5 Vdc to an external controller or I/O card.

2-25. Computer Interfacing.

2-26. For interfacing the Model 3575A Option 002 to an -hp- computer, it will be necessary to utilize the information in this manual to develop I/O circuitry and software that meets individual system requirements. For more

detailed information concerning the 3575A Option 002, refer to Paragraph 3-71.

2-27. Printer Interfacing.**

2-28. The 3575A Option 002 can be connected directly to an -hp- printer (Model 5050B or 5055A) using the -hp- 562A-16C printer cable. The 3575A BCD output and data flag connections are compatible with the 562A-16C cable and modifications to the printer or printer cable are not required. The printer, however, must be set or wired to accept ground-true BCD inputs and an external ground lead must be connected between the printer chassis and the 3575A chassis. In addition, there are two minor modifications that should be performed on the 3575A:

a. The Local/Remote control line (J1 pin 50) is automatically grounded when the 562A-16C printer cable is connected. Grounding the Local/Remote line enables the timing circuits in the 3575A but also disables the front panel controls and enables the remote control lines. Besides being inaccessible with the printer cable connected, the remote control lines (J1 pins 9 through 12, 34 through 37) are connected to the BCD input lines that control unused printer columns, 5 and 6. If remote control operation is desired, it will be necessary to fabricate an adapter that will isolate the unused printer-input lines and permit external connections to the 3575A control lines. If front panel operation is desired, connect the jumper wire on the 3575A Interface Assembly (A16B) between points 1 and 3 (see Paragraph 3-86).

b. When using a printer it is necessary to supply a Remote Measure command to the 3575A to initiate the measurement cycle. When the printer cable is connected to the 3575A, the Remote Measure line (J1 pin 21) is not accessible. For this reason, a test point labeled "TRIGGER" is provided on the Interface Assembly, A16B. The "trigger" test point is connected directly to the Remote Measure line. For convenience, install a female BNC connector (-hp- 1250-0083) in one of the holes provided on the rear panel (Item 13, Figure 3-2) and connect a short piece of wire between the BNC connector and the "trigger" test point on A16B. Apply the Remote Measure command to the BNC connector. (Also see Paragraph 3-80)

NOTE

The 562A-16C printer cable does not provide a solid ground connection between the printer and the 3575A. For this reason, it is necessary to connect an external ground lead (short piece of copper braid) between the printer chassis and the 3575A chassis.

2-29. For further information concerning the use of a printer with the 3575A Option 002, refer to Paragraph 3-87.

* Cinch No. 57-30500-375

** For Option 003 instruments, the printer must be set or wired to accept high-true BCD inputs.

SECTION III

OPERATING INSTRUCTIONS

3-1. INTRODUCTION.

3-2. This section contains complete operating instructions for the Model 3575A Gain-Phase Meter. Included is a description of controls, general operating information, a basic operating procedure and information concerning Option 001 through 003 instruments.

3-3. CONTROLS AND INDICATORS.

3-4. Figures 3-1 and 3-2 illustrate and describe the function of all front and rear panel controls, connectors and indicators. The description of each item is keyed to the drawing within the figure.

3-5. GENERAL OPERATING INFORMATION.

3-6. Input Connections.

3-7. The input signals can be applied to the 3575A through twisted pairs, shielded cables equipped with BNC connectors (-hp- 10503A Cable Assembly), or 10:1 divider probes (-hp- 10004A Voltage Divider Probe). Test leads should be kept as short as possible to minimize extraneous pickup and/or loss due to cable capacitance. When using 10:1 divider probes, it is first necessary to compensate the probes as outlined in Paragraph 3-62.

3-8. Grounding and Termination.

3-9. In the design of the 3575A, extra care has been taken to control internal ground currents that could degrade the accuracy of amplitude and phase readings. Due to its wide dynamic range and high sensitivity, however, the 3575A can be affected by external ground currents or "ground loops" that are caused by poor grounding or incorrect termination. This means that when using the 3575A, particularly at low levels and low frequencies, the operator must be extremely "ground conscious" if accurate, repeatable readings are to be obtained.

3-10. There are basically two types of ground loops that can cause measurement errors in the 3575A. The first type, commonly known as a power-line ground loop, is encountered at frequencies below the power-line frequency or at

integral multiples of the power-line frequency where either or both input signals are below 50 mV. The power-line ground loop is caused by extraneous currents that circulate between the signal source and the 3575A by way of power-line ground. The other type of ground loop is introduced by the signal source and is generally encountered at frequencies below 1 MHz where the signal applied to one channel is greater than 1 V rms and the signal applied to the other channel is less than 10 mV rms. These two types of ground loops are illustrated in Figures 3-3 and 3-4 and are discussed in the following paragraphs.

3-11. Power-Line Ground Loop. Figure 3-3A shows the input arrangement for a simple grounded measurement. Ein represents the source being measured along with any noise associated with it and is generally called the "normal-mode source". Rs represents the source resistance and the resistance of the high lead; Rg represents the resistance of the ground lead. Current from Ein (normal-mode current) flows through Rs, Z_1 and Rg and the instrument responds to the drop across Z_1 . As long as the grounds on both sides of Rg are identical, extraneous currents cannot circulate between the source ground and the instrument ground. If, however, the grounds are different due to voltage drops in the ground lead or currents induced into it, a new source is developed and the measurement appears as shown in Figure 3-3B. The new source, Ecm (the difference between grounds) is called the "common-mode source" because it is common to both the high and ground lines. Common-mode current can flow through Rg or through Rs and Z_1 . Since Z_1 is usually much larger than Rs and since they are both in parallel with Rg, most of the voltage across Rg will appear across Z_1 causing an error in the amplitude or phase reading.

3-12. To minimize power-line ground loops, the following guidelines should be observed:

- a. Keep input leads as short as possible.
- b. Provide good ground connections to minimize the resistance of Rg.
- c. Connect the signal source and the 3575A to the same power bus.
- d. If a removable ground strap is provided on the signal source, float the source to break the common-mode current path.

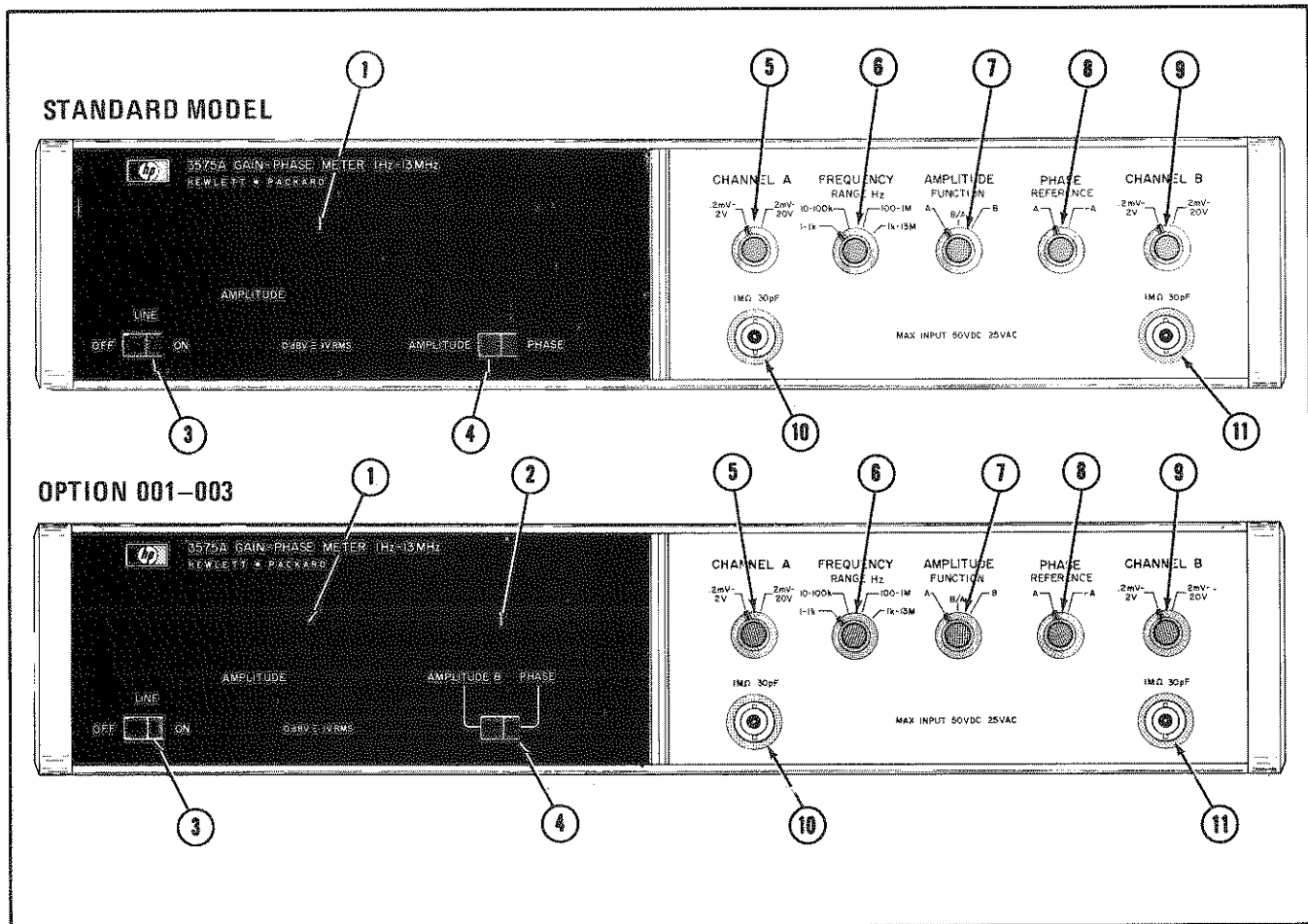

Figure 3-1. Front Panel Description.

- ① Panel Meter (Standard Model 3575A): Indicates amplitude or phase depending on position of DISPLAY switch (See Paragraphs 3-30 through 3-33).
- ① Left-Hand Panel Meter (Options 001-003): Indicates amplitude only and is controlled by the AMPLITUDE FUNCTION switch (See Paragraphs 3-32, 3-65 through 3-68).
- ② Right-Hand Panel Meter (Options 001-003 only): Indicates B dBV or phase depending on position of AMPLITUDE B/PHASE switch (See Paragraphs 3-33, 3-68 and 3-69).
- ③ LINE Switch: Applies line voltage to the instrument when set to the ON position.
- ④ DISPLAY Switch (Standard Model 3575A): Selects AMPLITUDE or PHASE presentation.
- ④ AMPLITUDE B/PHASE Switch (Options 001-003): Selects AMPLITUDE B (B dBV) or PHASE presentation for the Right-Hand Panel Meter.
- ⑤ Channel A Voltage Range Switch: Selects the input range for channel A (See Paragraphs 3-24 through 3-26).
- ⑥ FREQUENCY RANGE Switch: Selects any of four overlapping frequency ranges. The upper limit within each range applies to phase only. The lower limit applies to both amplitude and phase (See Para 3-27 through 3-29).
- ⑦ AMPLITUDE FUNCTION Switch (Standard Model 3575A): Controls the meter presentation when the DISPLAY switch is in the AMPLITUDE position. The AMPLITUDE FUNCTION switch selects any of three functions: Log A (A dBV), Log B (B dBV) or Log B/A (dB).
- ⑦ AMPLITUDE FUNCTION Switch (Options 001-003): Controls the Left-Hand Panel Meter presentation. As in the Standard Model 3575A, selects Log A (A dBV), Log B (B dBV) or Log B/A (dB).
- ⑧ PHASE REFERENCE Switch: Controls the phase of the reference channel, Channel A. With the PHASE REFERENCE switch set to the A position, the phase reading is direct. With the switch set to the -A position, the channel A signal is inverted and the phase reading is offset by 180 degrees (See Paragraphs 3-34 through 3-36).
- ⑨ Channel B Voltage Range Switch: Selects the input range for channel B (See Paragraphs 3-24 through 3-26).
- ⑩ Channel A Input Connector: Female BNC connector accepts 0.2 mV rms to 20 V rms, 1 Hz to 13 MHz input signal for channel A. Input impedance is 1 Megohm (nominal) 30 pF (See Paragraphs 3-6 and 3-7).
- ⑪ Channel B Input Connector: Female BNC connector accepts 0.2 mV rms to 20 V rms, 1 Hz to 13 MHz input signal for channel B. Input impedance is 1 Megohm (nominal) 30 pF (See Paragraphs 3-6 and 3-7).

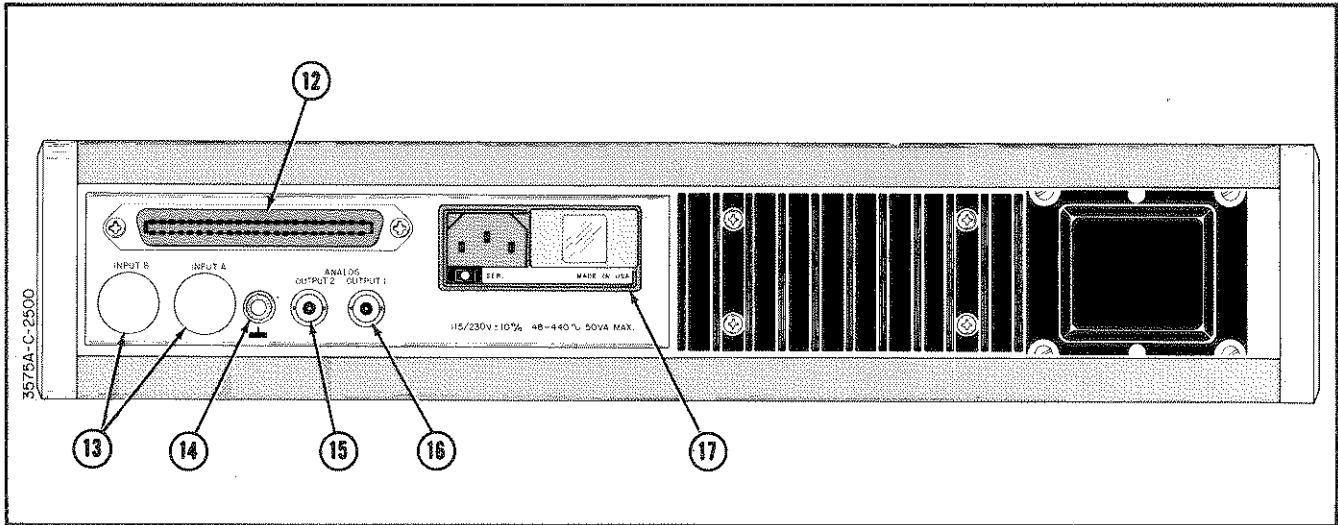

Figure 3-2. Rear Panel Description.

- 12 Interface Connector, A19J1 (Options 002, 003 only): Accepts low-tru \bar{e} binary inputs for remote control of all front panel functions, ranges and settings. Supplies 8-4-2-1 BCD-coded outputs for the two panel meters (See Paragraphs 3-71 through 3-74).
- 13 Holes: Provided for installing rear panel input connectors in place of the front panel connectors.
- 14 Ground Terminal: Connected to circuit ground and outer chassis ground. Terminal permits connection to chassis of signal source or to other external ground to help minimize ground loops (See Paragraph 3-17).
- 15 ANALOG OUTPUT 2 (Options 001–003 only): Supplies dc voltage (10 mV/dBV or 10 mV/deg.) that corresponds with the Right-Hand Panel Meter reading (See Paragraphs 3-37 through 3-40).
- 16 ANALOG OUTPUT 1 (Standard Model 3575A): Supplies dc voltage (10 mV/dB or 10 mV/degree) that corresponds with the panel meter reading. (See Paragraphs 3-37 and 3-38).
- 16 ANALOG OUTPUT 1 (Options 001–003): Supplies dc voltage (10 mV/dB) that corresponds with Left-Hand Panel Meter reading (See Paragraphs 3-37 through 3-40).
- 17 Power Input Module (A18): Accepts power cord supplied with the instrument. Contains line fuse and 115 V/230 V selector switch (See Figure 3-5).

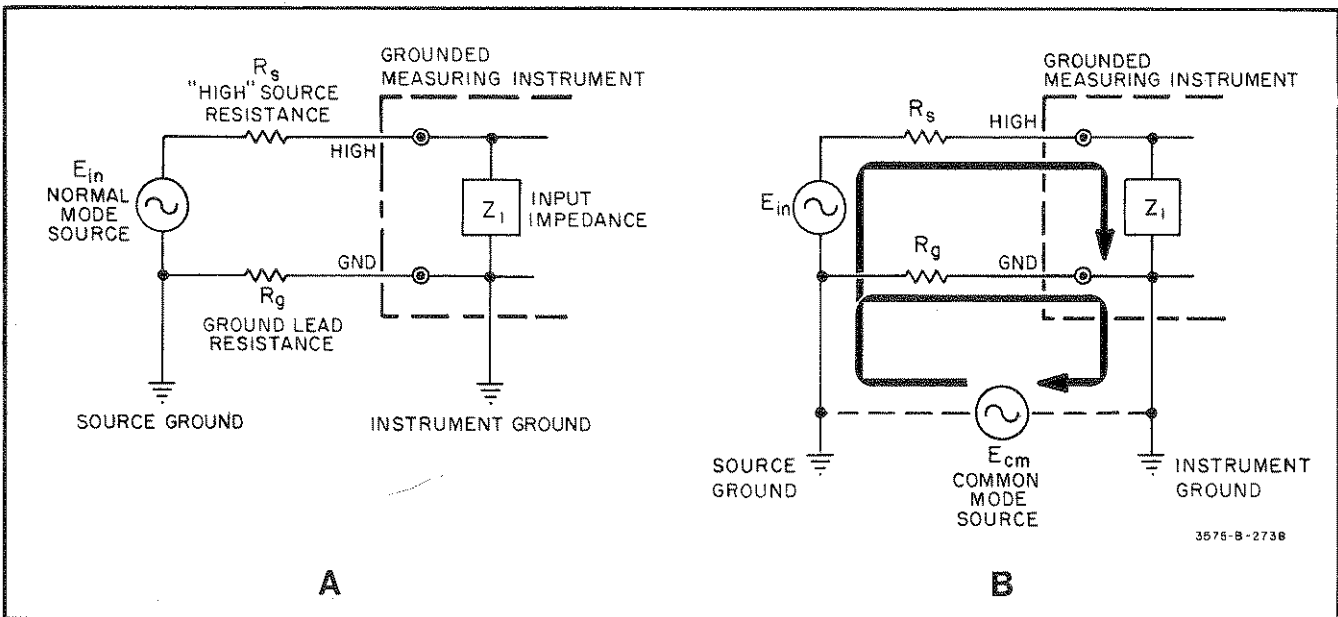

Figure 3-3. Power-Line Ground Loop.

3-13. Source-induced Ground Loop. Figure 3-4 illustrates a ground loop that is introduced by the signal source. In Figure 3-4, the signal applied to channel A is 2 V rms and the signal applied to channel B is 0.2 mV rms. As illustrated in the figure, part of the current from the 2 V source returns through the ground lead of the 0.2 mV source producing a voltage drop across the ground lead resistance, R_g . As in the power-line ground loop, the source resistance, R_s and the ground lead resistance R_g are in parallel with Z_b . Due to the 50 ohm termination placed directly across Z_b , however, less than half of the voltage dropped across R_g is present across Z_b . Although this voltage is very small, it is large enough to affect the amplitude and/or phase of the 0.2 mV signal.

3-14. Note that most of the current from the 2 V source is flowing through the 50 ohm termination of the channel A input and depending on the resistance between the A and B input commons, a good portion of the current is returning through the channel B ground lead. If the 50 ohm termination was placed directly across the output of the 2 V source, however, very little current would flow in the ground leads. Lowering the current in the ground leads reduces the drop across R_g and thereby minimizes the common-mode voltage and the resulting error.

3-15. Fortunately, this type of ground loop is predominate at low frequencies (below 1 MHz) where it is possible to terminate at the signal source rather than at the input of the measuring instrument. At high frequencies where it is necessary to terminate at the end of the transmission line, the error is normally insignificant as long as shielded cables or twisted pairs are used for the input connections.

3-16. To minimize ground currents introduced by the signal source, observe the following guidelines:

a. At frequencies below 1 MHz, place the termination for the high-level signal directly across the output of the high-level signal source.

1) At frequencies above 1 MHz, terminate at the 3575A input.

b. If termination for the low-level signal is required, place the termination at the input of the 3575A.

c. Provide good ground connections by using shielded cables equipped with BNC connectors. If shielded cables are not available, use twisted leads.

d. Keep input cables and leads as short as possible.

3-17. Checking For Ground Loops. To check for power-line ground loops, proceed as follows:

a. Apply a 0.2 mV to 50 mV rms, 1 Hz to 60 Hz (or other power-line frequency) signal to either or both of the 3575A inputs.

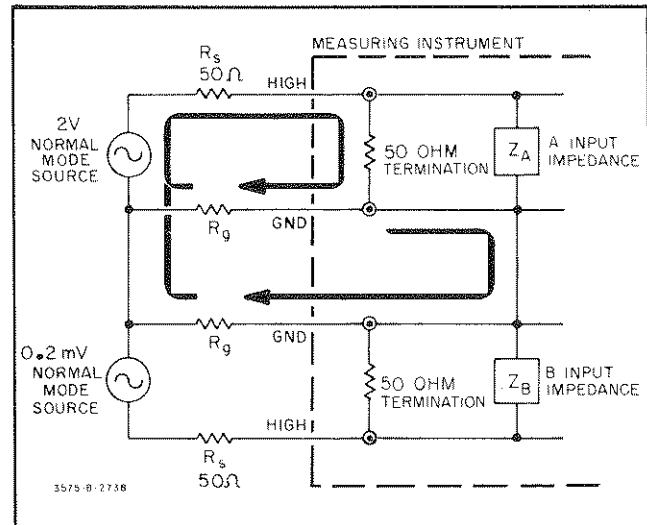

Figure 3-4. Source-Induced Ground Loop.

b. Set the 3575A to measure the amplitude of the applied signal and note the panel meter reading.

c. Connect a short piece of copper braid between the common terminal of the signal source and the 3575A input common (on one of the BNC input connectors).

d. Allow time for the instrument to stabilize and again note the panel meter reading.

e. If connecting the copper braid has produced a significant change (± 0.5 dB) in the reading, a ground loop is present and corrective action (Paragraph 3-12) should be taken.

NOTE

A ground terminal (Item 14, Figure 3-2) is provided on the 3575A rear panel to permit external grounding. In cases where ground loops are critical and difficult to control, it is sometimes beneficial to connect a short piece of copper braid between this ground terminal and the chassis of the signal source. Factory tests have indicated, however, that the length and positioning of the copper braid can be critical. Before using this technique in a measurement application, experiment with various ground points, lead lengths and lead positions to establish a grounding method that ensures accurate, repeatable readings in your particular situation.

3-18. To check for source induced ground loops, proceed as follows:

a. Apply a 1 V to 20 V rms, 10 Hz to 10 kHz signal to one channel and a 0.2 mV to 10 mV rms signal to the other channel.

b. Set the 3575A to measure the amplitude of the low level signal and note the panel meter reading.

c. Disconnect the high level signal from the 3575A.

d. Allow time for the instrument to stabilize and again note the low level amplitude reading.

e. If disconnecting the high level signal has produced a significant change (± 0.5 dB) in the low level reading, a ground loop is present and corrective action (Paragraph 3-16) should be taken.

3-19. Input Constraints.

3-20. The 80 dB dynamic range of the 3575A provides wide freedom from input constraints. In many cases, it will be possible to make all the necessary measurements without changing voltage ranges. It is important, however, to observe the maximum input levels (2 V rms or 20 V rms) indicated by the Voltage Range setting. Exceeding these input levels will cause the display to blank, the overload indicator (A_{OL} or B_{OL}) to illuminate and can damage the instrument if the applied voltage is greater than 25 V rms or 50 V dc.

3-21. DC Isolation.

3-22. The 3575A inputs are equipped with coupling capacitors to provide dc isolation. The maximum dc voltage that can be safely applied to the inputs is ± 50 Vdc. Exceeding this limit can cause breakdown of the input capacitors resulting in damage to the input amplifier circuitry.

3-23. The 3575A cannot be operated in a floating condition. All Input and Output commons are connected directly to outer chassis (frame) ground which connects to earth ground through the offset pin on the power cord connector.

3-24. Voltage Ranges.

3-25. Each input channel is equipped with a range switch which permits selection of two overlapping voltage ranges. Input voltage limits within each range are as follows:

- 0.2 mV rms (- 74 dBV) to 2 V rms (+ 6 dBV)
- 2 mV rms (- 54 dBV) to 20 V rms (+ 26 dBV)

3-26. As long as the applied signal is within the limits of both ranges (2 mV to 2 V), either range setting can be used. Changing the voltage range setting does not affect the display resolution. For optimum accuracy, however, it is recommended that the 0.2 mV to 2 V range be used at all times unless the applied signal is greater than 2 V rms. The reason for this is that on the 2 mV to 20 V range the input signal is divided by the 20 dB input attenuator. Any noise that is generated within the 3575A, however, is not attenuated and the signal to noise ratio is decreased. Decreasing the signal to noise ratio makes the instrument more susceptible to noise which can affect the accuracy of amplitude and phase readings. It should be noted that the Phase Accuracy specifications (Table 1-1) are met only when the lowest applicable voltage range settings are used.

3-27. Frequency Ranges.

3-28. The broadband frequency response of the 3575A extends from 1 Hz to 13 MHz in four overlapping ranges. Frequency limits within each range are as follows:

- 1 Hz to 1 kHz
- 10 Hz to 100 kHz
- 100 Hz to 1 MHz
- 1 kHz to 13 MHz

3-29. The FREQUENCY RANGE setting determines the amount of filtering that is used throughout the instrument. The filtering, in turn, controls the frequency response and overall settling time (See Table 3-1). The frequency ranges are designed such that the lower limit of each range applies to both amplitude and phase and the upper limit applies only to phase. For example, it is possible to use the 1 Hz to 1 kHz range for all *amplitude* measurements within the frequency range of 1 Hz to 13 MHz. For most amplitude measurements, however, it is best to use one of the upper ranges to minimize settling time. The main thing to remember when making amplitude measurements is that the frequency of the input signal(s) must be above the lower limit of the selected frequency range. When measuring phase, it is necessary to observe both the upper and lower limits of each frequency range. The upper limits, which apply to phase only, are determined by noise filters which control the high frequency cutoff characteristics of the phase detector circuits. For optimum phase accuracy, it is necessary to use the frequency range that provides the greatest noise immunity *and* the required bandpass. This means that the *lowest* range that covers the frequency of the input signals must be used. It should be noted that the Phase Accuracy specifications (Table 1-1) are met only on the lowest applicable frequency range.

Table 3-1. Typical Settling Time.
(following a change in input parameters)

Frequency Range	100 % * Settled	95 % * Settled	90 % * Settled
1 Hz - 1 kHz	30 sec.	20 sec.	17 sec.
10 Hz - 100 kHz	3 sec.	2 sec.	1.7 sec.
100 Hz - 1 MHz	0.3 sec.	0.2 sec.	0.17 sec.
1 kHz - 13 MHz	30 ms.	20 ms.	17 ms.

* Percent of final reading.

3-30. Meter Indication.

3-31. The 3575A panel meter indicates directly in dB or dBV for amplitude measurements and in degrees for phase measurements. The front panel DISPLAY switch permits selection of either AMPLITUDE or PHASE presentation.

3-32. Amplitude Presentation. With the DISPLAY switch in the AMPLITUDE position, the meter presentation is determined by the AMPLITUDE FUNCTION control setting. The three amplitude functions are: Log A, Log B

and Log B/A. When A or B is selected, the panel meter indicates the amplitude of the corresponding input signal in dBV (1 V rms = 0 dBV). The overall measurement range for the Log A and Log B amplitude functions is from -74 dBV (0.2 mV rms) to +26 dBV (20 V rms) providing a total of 100 dB in two voltage ranges. The 3575A amplitude readings are displayed with 0.1 dBV resolution over the entire measurement range. When B/A is selected, the 3575A measures the relative amplitude of (difference between) the two input signals in dB. The display range for relative measurements is from -100 dB to +100 dB with 0.1 dB resolution. Relative amplitude readings are displayed with respect to channel A which is the reference channel. A negative reading indicates that the signal applied to channel B is *lower* in amplitude than the signal applied to channel A. A positive reading indicates that the signal applied to channel B is *greater* in amplitude than the signal applied to channel A.

3-33. Phase Presentation. With the DISPLAY switch in the PHASE position, the panel meter indicates the phase difference between the two input signals in degrees. The display range for phase measurements is from -192 degrees to +192 degrees with 0.1 degree resolution. The ± 192 degree limits provide a ± 12 degree overrange capability which eliminates ambiguous readings in the ± 180 degree region.

3-34. Phase Reference. The 3575A phase readings are displayed with respect to channel A which is the reference channel. A negative phase reading indicates that B lags A; a positive phase reading means that B leads A.

3-35. With the PHASE REFERENCE switch in the +A position, the panel meter indicates the actual phase difference between the two input signals. With the PHASE REFERENCE switch in the -A position, channel A is inverted and the phase reading is offset by 180 degrees. For example, with a phase difference of +60 degrees (B leads A) applied to the inputs and the PHASE REFERENCE switch set to the +A position, the panel meter will indicate +60 degrees. If the PHASE REFERENCE switch is changed to the -A position, channel A will be inverted and the panel meter will indicate -120 degrees.

3-36. Because of the ± 12 degree overrange capability, the 3575A never gives ambiguous phase readings. This means that it is not necessary to change the phase reference for measurements in the ± 180 degree region. The ability to change the phase reference is strictly a convenience feature which is useful for some measurement applications. One example of this is where it is necessary to make a continuous phase vs. frequency plot over 360 degrees of range. Consider the case where two signals are initially in phase and as frequency is varied the phase difference increases in a positive direction. With the phase reference set to +A, the plot starts out at 0 degrees and increases with frequency until the phase difference reaches approximately +192 degrees. At this time, the 3575A reading automatically jumps to -168 degrees and again goes more positive with frequency. The result is a discontinuous plot.

By initially setting the phase reference to -A, however, a continuous plot could be obtained. The plot would start out at -180 degrees and continue in a positive direction through +192 degrees extending the continuous range by 180 degrees.

3-37. Analog Outputs.

3-38. Two BNC connectors, labeled ANALOG OUTPUT 1 and ANALOG OUTPUT 2, are located on the rear panel of the instrument. On the standard Model 3575A, ANALOG OUTPUT 2 is not used. The remaining connector, ANALOG OUTPUT 1, is connected through a 1 kilohm resistor to the analog (dc) voltage applied to the panel meter. Since this voltage is not affected by errors within the panel meter, it is more accurate than the panel meter reading. For this reason, the amplitude and phase accuracy specifications listed in Table 1-1 apply to the analog output and do not reflect the ± 3 count panel meter tolerance. The analog output voltage is defined in the accuracy specifications as 10 mV per degree for phase measurements and 10 mV per dB/dBV for amplitude measurements (with > 2 Megohm load resistance). In the Amplitude Display mode, the analog output voltage ranges from -1 Vdc (-100 dB) to +1 Vdc (+100 dB). In the Phase Display mode the voltage ranges from -1.92 Vdc (-192 degrees) to +1.92 Vdc (+192 degrees). The analog output resistance is 1 Kilohm and short-circuit protection is provided. To obtain an output of 10 mV per degree or 10 mV per dB/dBV, the load resistance connected to the analog output must be 2 Megohm or greater. Additional loading will not damage the instrument or degrade the linearity but it will reduce the output voltage by an amount proportional to the load resistance.

3-39. Dual Analog Outputs (Options 001 through 003).

3-40. For instruments equipped with dual panel meters, ANALOG OUTPUT 1 is connected to the left-hand (facing the front panel) panel meter (amplitude) and ANALOG OUTPUT 2 is connected to the right-hand panel meter (phase). The analog output voltages correspond with the respective panel meter readings and can be used for simultaneous amplitude and phase plotting. For further information concerning Options 001-003, refer to Paragraph 3-64.

3-41. BASIC OPERATING PROCEDURE.

3-42. Instrument Turn On.

- a. Refer to Figure 3-5 and perform the following:

- 1) Remove the fuse and set the line selector switch to correspond with the line voltage to be used (115 V or 230 V).

- 2) Replace the fuse using a 0.6A, 250 V slo-blo for 115 V operation or a 0.3A, 250 V slo-blo for 230 V operation.

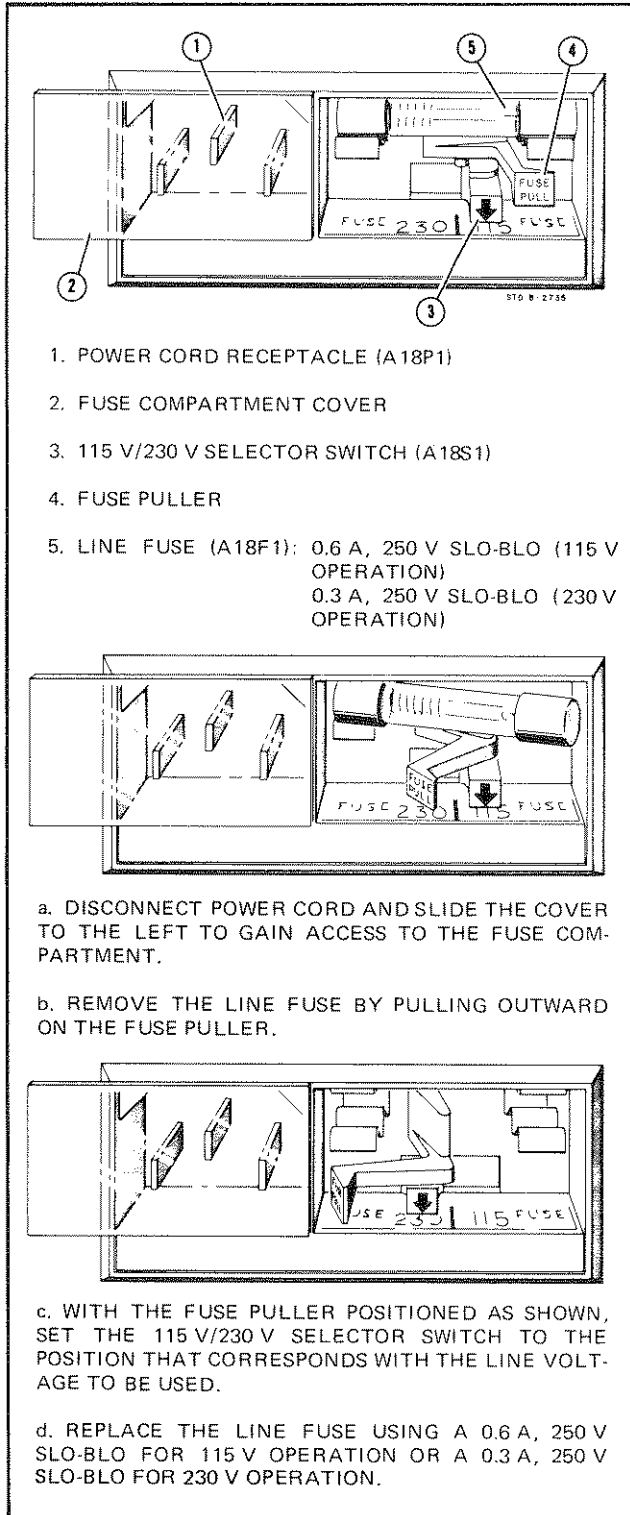

Figure 3-5. Power Input Module A, B and C.

b. Connect the detachable ac power cord to the rear panel power receptacle and to the power source (115 V or 230 V, 48 Hz to 440 Hz).

c. Set the LINE switch to the ON position. The panel meter display will illuminate. With no inputs applied to the

3575A, the instrument will respond to extraneous pickup and residual noise. For this reason, the display may not stabilize until inputs are applied.

3-43. Amplitude Measurements.

3-44. Log A and Log B Measurements. The single channel amplitude functions, A or B, permit direct measurement of either input level in dBV. These readings can be converted to ac volts using the graph shown in Figure 3-6. To measure the level applied to either input channel, proceed as follows:

- a. Set the DISPLAY switch to the AMPLITUDE position.
- b. Set the AMPLITUDE FUNCTION switch to A or B depending on which input is to be measured.
- c. Set the Voltage Range and FREQUENCY RANGE switches to appropriate settings as outlined in Paragraphs 3-24 and 3-27.
- d. Apply signal to the appropriate input channel.
- e. Allow time for the reading to stabilize.
- f. Observe the amplitude reading in dBV.
- g. If desired, convert the dBV reading to rms volts using the graph shown in Figure 3-6.

3-45. Relative Measurements (Log B/A). In the B/A amplitude function, the 3575A measures the relative amplitude of the two input signals in dB. This function is particularly useful for measuring gain, attenuation and frequency response. The use of simultaneous comparison eliminates the need for separate input and output measurements and provides relative readings that are independent of source variations.

3-46. Because the two input channels are totally independent, relative measurements can be made between two signals that differ in frequency. It should be noted, however, that both input frequencies must be above the lower limit of the selected frequency range (see Paragraph 3-27).

3-47. For relative measurements using the B/A function, proceed as follows:

- a. Set the DISPLAY switch to the AMPLITUDE position.
- b. Set the AMPLITUDE FUNCTION switch to B/A.
- c. Set the Voltage Range and FREQUENCY RANGE switches as outlined in Paragraphs 3-24, 3-27 and 3-46.

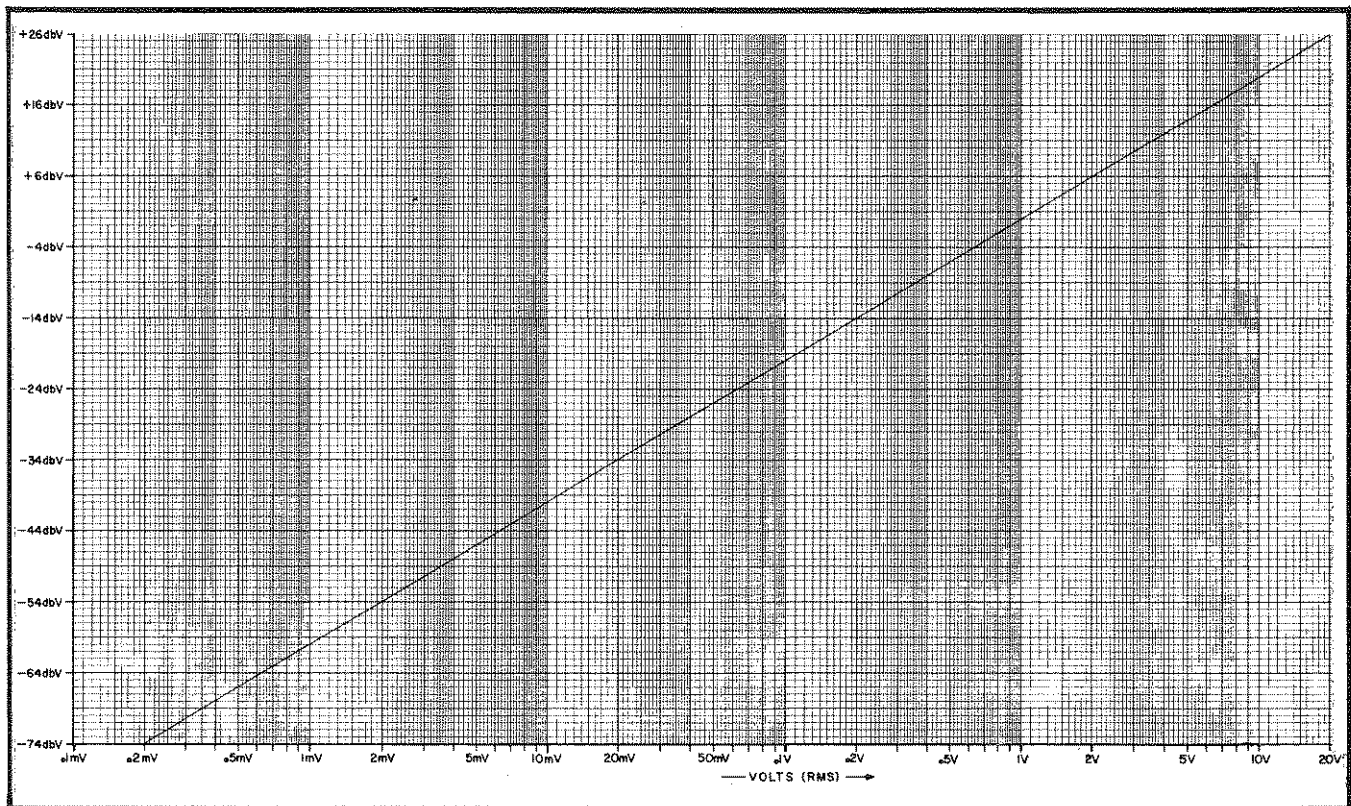

Figure 3-6. dBV to Volts Conversion.

d. Remembering that channel A is the reference channel, connect the signals to be measured to the 3575A Input connectors.

e. Allow time for the reading to stabilize.

f. Observe the relative amplitude reading in dB. A negative reading indicates that B is lower than A; a positive reading means that B is greater than A.

g. When making relative measurements ensure that the input levels are within the limits of the voltage range settings being used.

3-48. Phase Measurements.

3-49. With the DISPLAY switch in the PHASE position, the 3575A measures the phase difference between the two input signals in degrees. To measure phase, proceed as follows:

a. Set the DISPLAY switch to the PHASE position.

b. Set the PHASE REFERENCE switch to +A or as outlined in Paragraph 3-34.

c. Set the Voltage Range and FREQUENCY RANGE switches as outlined in Paragraphs 3-24 and 3-27.

d. Connect the signals to be measured to the 3575A Input connectors.

e. Allow time for the reading to stabilize.

f. Observe the phase reading. Since A is the reference channel, a negative reading indicates that B lags A; a positive reading indicates that B leads A.

3-50. Effects of Harmonic Distortion on Phase Readings. In the 3575A, phase difference is measured between the zero crossing points of the applied signals. If an applied signal contains harmonics of the fundamental frequency, the zero crossings may be shifted with respect to a pure sine wave. If the instrument responds to the false crossings introduced by the distortion, an erroneous offset will appear in the phase reading.

3-51. The amount of error introduced by harmonic distortion depends on the magnitude, phase and order of the harmonics. Harmonics that are in phase with the fundamental (such as in a square wave) do not change the zero crossing points and do not affect the phase reading. In the 3575A, the effects of even harmonics are cancelled by two phase detectors that operate 180 degrees out of phase. For this reason, even harmonics, regardless of their phase, do not affect the phase reading. This leaves only odd harmonics that are out of phase with the fundamental.

3-52. The amount of error introduced by odd harmonic distortion again depends on the magnitude and phase of the harmonics. The largest error occurs when the odd harmonics are 90 degrees out of phase with the fundamental. In

this case, the distortion is at its peak amplitude when the fundamental is at the zero crossing point.

3-53. The graph shown in Figure 3-7 can be used to determine the approximate worst-case error introduced by odd, out-of-phase harmonics. As indicated in the graph, the worst-case error for odd harmonics 40 dB below the fundamental is approximately 0.57 degrees.

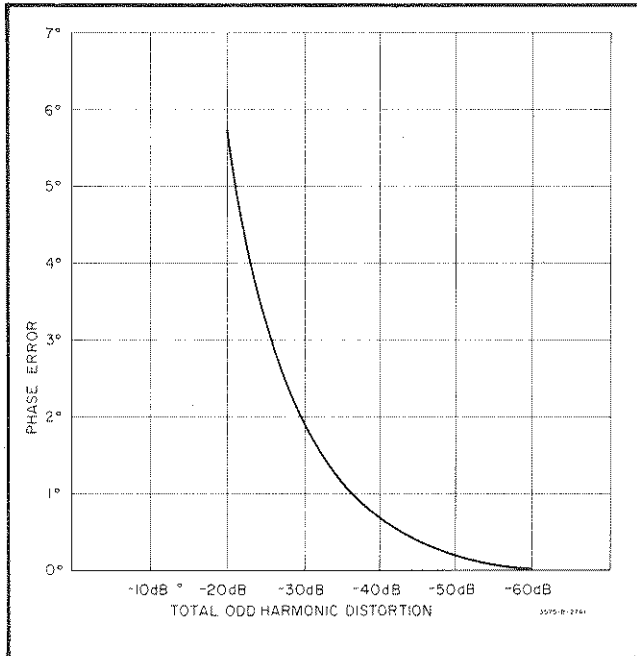

Figure 3-7. Worst Case Error Produced by Odd Harmonics.

3-54. Effects of Noise on Phase Readings. The 3575A uses a unique phase measuring scheme which minimizes the effects of noise by a process of detection, cancellation and correction. This, in conjunction with the broadband filtering that is used throughout the instrument, virtually eliminates ambiguous readings and 180 degree errors. This does not mean, however, that the effects of noise are completely eliminated. With applied signal to noise ratios of < 30 dB, noise can produce erroneous offsets. The amount of offset depends of the signal to noise ratio while the offset polarity depends on which channel the noise appears. The effects of noise are minimized under the following conditions:

- a. When the noise level on both channels is more than 30 dB below the signal level (signal to noise ratio > 30 dB).
- b. When readings are more than 10 degrees away from 0 degrees, ± 90 degrees and ± 180 degrees and the noise is on the channel indicated (by shaded areas) in Table 3-2.

3-55. Effects of Source Impedance on Phase Readings. Due to the internal shunt capacitance and any external cable capacitance connected to the 3575A inputs, the phase of an applied signal can be affected by the impedance of the signal source or network under test. This

Table 3-2. Effects of Noise Minimized.

	- 170° to - 100°	- 80° to - 10°	10° to 80°	100° to 170°
Chan A				
Chan B				

can be illustrated by a simple R/C network such as the one shown in Figure 3-8. In Figure 3-8, the source impedance is represented by a resistor (R_s) and the internal shunt capacitance is represented by a capacitor (C_s). The overall shunt capacitance is increased by C_x which represents the external cable capacitance between the source and the 3575A input. The amount of phase shift developed across the shunt capacitance depends on three variables: the effective shunt capacitance ($C_s + C_x$), the source impedance (R_s) and the frequency of the applied signal (F_o). Increasing any of these variables increases the phase shift of the network. If the source impedance is resistive, the phase shift can be calculated using the following formula:

$$\text{Tan. } \phi = \frac{R_s}{X_{C_s}}$$

Where: ϕ = phase shift in degrees
 R_s = source resistance
 X_{C_s} = reactance of the effective shunt capacitance ($C_s + C_x$) where $C_s = 30$ pF and $C_x =$ external cable capacitance (approximately 20 pF per foot for RG - 58/U)

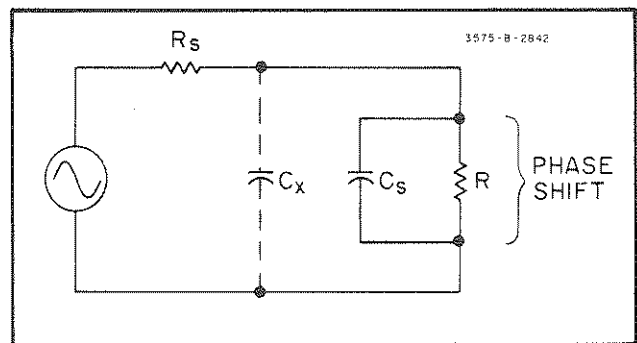

Figure 3-8. Simple RC Network.

3-56. Since the internal shunt capacitance of channel A is closely matched to that of channel B, the phase measurement accuracy will not be affected if the source impedance and the external cable capacitance is the same on both channels. In this case, both channels exhibit the same amount of phase shift and the relative phase of the applied signals remains unchanged.

3-57. In most phase measurement applications it is impractical to maintain the same source impedance and cable

capacitance on both channels. The effects of source impedance can be minimized, however, by the use of 10 Megohm 10:1 divider probes (-hp- 10004A) which reduce the effective shunt capacitance to approximately 10 pF.

3-58. Table 3-3 can be used to determine the reactance of the 10 pF probe capacitance over the entire frequency spectrum. A general "rule of thumb" is that the capacitive reactance of the 10 pF probe should be at least 100 times the *difference* between the two source impedances at the highest operating frequency. If this rule is applied, the maximum or "worst-case" error will be less than 0.6 degrees. If 10 pF divider probes are used and the two source impedances are primarily resistive, the phase error can be approximated using the following formula:

$$\text{Tan. } \phi = \frac{|R_{sa} - R_{sb}|}{X_c}$$

Where: ϕ = phase error in degrees
 R_{sa} = source resistance of channel A
 R_{sb} = source resistance of channel B
 X_c = reactance of 10 pF divider probe at the operating frequency

3-59. Using 10:1 Divider Probes.

3-60. The 3575A input channels are designed to permit the use of 10 Megohm, 10 pF Voltage Divider Probes (-hp-10004A). These probes can be used to extend the maximum input levels to 200 V rms and the overall operating range to 120 dB. Voltage divider probes also reduce the effective shunt capacitance to approximately 10 pF and thereby minimize errors due to source impedance (Paragraph 3-55).

3-61. When using 10:1 divider probes, the following guidelines should be observed:

- a. Use 10 Megohm, 10 pF Divider Probes (-hp- 10004A or equivalent) only. Other probes can create errors particularly when measuring phase at high frequencies.
- b. Before using 10:1 divider probes, compensate the probes as outlined in Paragraph 3-62.
- c. Do not use a 10:1 divider probe on one channel and a direct input to the other channel.
- d. Use the lowest voltage range that provides the required measurement capability.
- e. Note that when 10:1 divider probes are used, the single channel amplitude readings (Log A and Log B) will be offset by - 20 dBV e.g., 1 V rms applied to probe will measure - 20 dBV rather than 0 dBV. Relative readings (B/A) will not be offset if identical probes are used.

3-62. Probe Compensation. Before using 10:1 divider probes it is necessary to adjust the probes for optimum flatness and identical phase characteristics. Once the probes are properly adjusted they should not require further attention unless they are interchanged or inadvertently misadjusted. It is good practice, however, to perform periodic verification checks to ensure that optimum adjustment is maintained.

3-63. The following probe adjustments should be performed with a 1 V rms sine wave applied to both probes:

REQUIRED EQUIPMENT: Test Oscillator (-hp- 651B)
 50 Ohm Feedthru Termination (-hp- 11048B)

- a. Connect 50 ohm output of test oscillator, terminated in 50 ohm load, to both 3575A input probes.

Table 3-3. Reactance of 10 pF Probe.

Frequency	Reactance	Frequency	Reactance	Frequency	Reactance	Frequency	Reactance
10 Hz	1591 M	700 Hz	22.74 M	30 kHz	530 K	800 kHz	19.9 K
20 Hz	795.7 M	800 Hz	19.89 M	40 kHz	398 K	900 kHz	17.7 K
30 Hz	530.5 M	900 Hz	17.68 M	50 kHz	318 K		
40 Hz	397.9 M			60 kHz	265 K	1 MHz	15.9 K
50 Hz	318.3 M	1 kHz	15.91 M	70 kHz	227 K	2 MHz	7.96 K
60 Hz	265.3 M	2 kHz	7.96 M	80 kHz	199 K	3 MHz	5.30 K
70 Hz	227.4 M	3 kHz	5.30 M	90 kHz	177 K	4 MHz	3.98 K
80 Hz	198.9 M	4 kHz	3.98 M			5 MHz	3.18 K
90 Hz	176.8 M	5 kHz	3.18 M	100 kHz	159 K	6 MHz	2.65 K
		6 kHz	2.65 M	200 kHz	79.6 K	7 MHz	2.27 K
100 Hz	159.1 M	7 kHz	2.27 M	300 kHz	53.0 K	8 MHz	1.99 K
200 Hz	79.57 M	8 kHz	1.99 M	400 kHz	39.8 K	9 MHz	1.77 K
300 Hz	53.05 M	9 kHz	1.77 M	500 kHz	31.8 K		
400 Hz	39.79 M			600 kHz	26.5 K	10 MHz	1.59 K
500 Hz	31.83 M	10 kHz	1.59 M	700 kHz	22.7 K	13 MHz	1.22 K
600 Hz	26.53 M	20 kHz	796 K				

b. Set the 3575A controls as follows:

DISPLAY AMPLITUDE
 Voltage Range 0.2 mV to 2 V
 (both channels)
 AMPLITUDE FUNCTION A
 FREQUENCY RANGE 100 - 1 M
 PHASE REFERENCE A

c. Set the test oscillator for an output of 1 V rms, 100 Hz.

d. Record the channel A amplitude reading: ___ dBV.

e. Establish a reference level on the meter of the test oscillator and use the oscillator amplitude control to maintain this reference level whenever the frequency is varied.

f. Set the test oscillator frequency to 1 MHz.

g. Adjust the channel A probe for the same reading recorded in Step d.

h. Repeat Steps c through g until optimum adjustment is obtained.

i. Set the test oscillator frequency to 1.5 kHz.

j. Set the 3575A DISPLAY switch to PHASE.

k. Adjust the channel B probe for a phase reading of 0 degrees ± 0.2 degrees.

l. Set the 3575A DISPLAY switch to AMPLITUDE; set the AMPLITUDE FUNCTION switch to B/A.

m. Set the test oscillator frequency to 1 MHz.

n. The B/A reading should be 0 dB ± 0.2 dB. If it is not, perform the following:

- 1) Repeat the probe adjustment procedure.
- 2) Replace the probes one at a time to determine if the problem is caused by faulty probes.
- 3) Perform the adjustment procedures outlined in Section V.

3-64. OPTIONS.

3-65. Option 001.

3-66. The 3575A Option 001 is equipped with dual panel meters to provide simultaneous amplitude and phase presentations. This option is also equipped with two analog outputs to permit amplitude vs. phase plotting.

3-67. In the 3575A Option 001, the left-hand (facing the front panel) panel meter always indicates amplitude. This panel meter is controlled by the AMPLITUDE FUNCTION switch which, as in the standard Model 3575A, permits selection of Log A, Log B or Log B/A.

3-68. The right-hand panel meter can indicate amplitude or phase depending on the position of the AMPLITUDE B/PHASE switch. With the switch in the AMPLITUDE B position, the right-hand panel meter indicates the amplitude of the signal applied to channel B (B dBV). Since the left-hand panel meter can indicate A dBV, B dBV or B/A, the following amplitude functions can be displayed simultaneously on the two panel meters:

Amplitude Function	Left-hand Panel Meter	Right-hand Panel Meter
A	A dBV	B dBV
B	B dBV	B dBV
B/A	B/A (dB)	B dBV

3-69. With the AMPLITUDE B/PHASE switch in the PHASE position, the right-hand panel meter indicates phase. The phase readings are controlled by the PHASE REFERENCE switch and are displayed as outlined in Paragraphs 3-33 through 3-36.

3-70. Analog Outputs. The 3575A Option 001 is equipped with two rear panel output (BNC) connectors labeled ANALOG OUTPUT 1 and ANALOG OUTPUT 2. Analog Output 1 is connected with the left-hand (amplitude) panel meter and Analog Output 2 is connected with the right-hand panel meter. The dc voltages at the analog outputs correspond with the respective panel meter readings as outlined in Paragraph 3-37.

3-71. Options 002 and 003.

NOTE

The 3575A Options 002 and 003 are identical except that Option 003 instruments use high-true logic for the BCD outputs. In all other respects, the following information for Option 002 instruments also applies to Option 003.

3-72. The 3575A Option 002 is a fully programmable instrument with dual BCD outputs and a complete remote control capability. Like the Option 001, the 3575A Option 002 is equipped with dual panel meters for simultaneous amplitude and phase presentations. Dual analog outputs are provided along with the BCD outputs to make the instrument compatible with various types of control systems and recording devices.

3-73. Remote Logic. The 3575A Option 002 uses ground true logic for the BCD outputs and remote control lines. Logic levels for the BCD outputs are as follows: *

True (1) = 0 V to +0.4 V, 12 mA maximum
 False (0) = +2.4 V to +5 V, 0.4 mA maximum

Logic levels for the remote control lines are as follows:

True (1) = ground or -0.5 V to +0.4 V, 1.6 mA maximum
 False (0) = open or +2.4 V to +5 V (5.6 K pullup resistance)

* Option 003 instruments use high-true logic for BCD outputs.

3-74. Remote Pin Connections. Figure 3-9 illustrates the 3575A Option 002 Interface connector as viewed from the rear of the instrument. The connector diagram and the table within the figure provides complete programming information. A 50-pin mating connector (-hp- 1251-0086)* and a 46-conductor cable are required for a complete remote programming capability (including remote control lines, BCD outputs, overload outputs, data flags, +5 V and circuit ground).



THE REMOTE INPUT AND OUTPUT LINES IN THE 3575A OPTION 002 ARE NOT ISOLATED. ALL INPUT AND OUTPUT LINES ARE REFERENCED TO CIRCUIT GROUND WHICH IS PERMANENTLY CONNECTED TO THE CHASSIS. THE CHASSIS CONNECTS TO EARTH GROUND THROUGH THE OFFSET PIN ON THE POWER-CORD CONNECTOR.

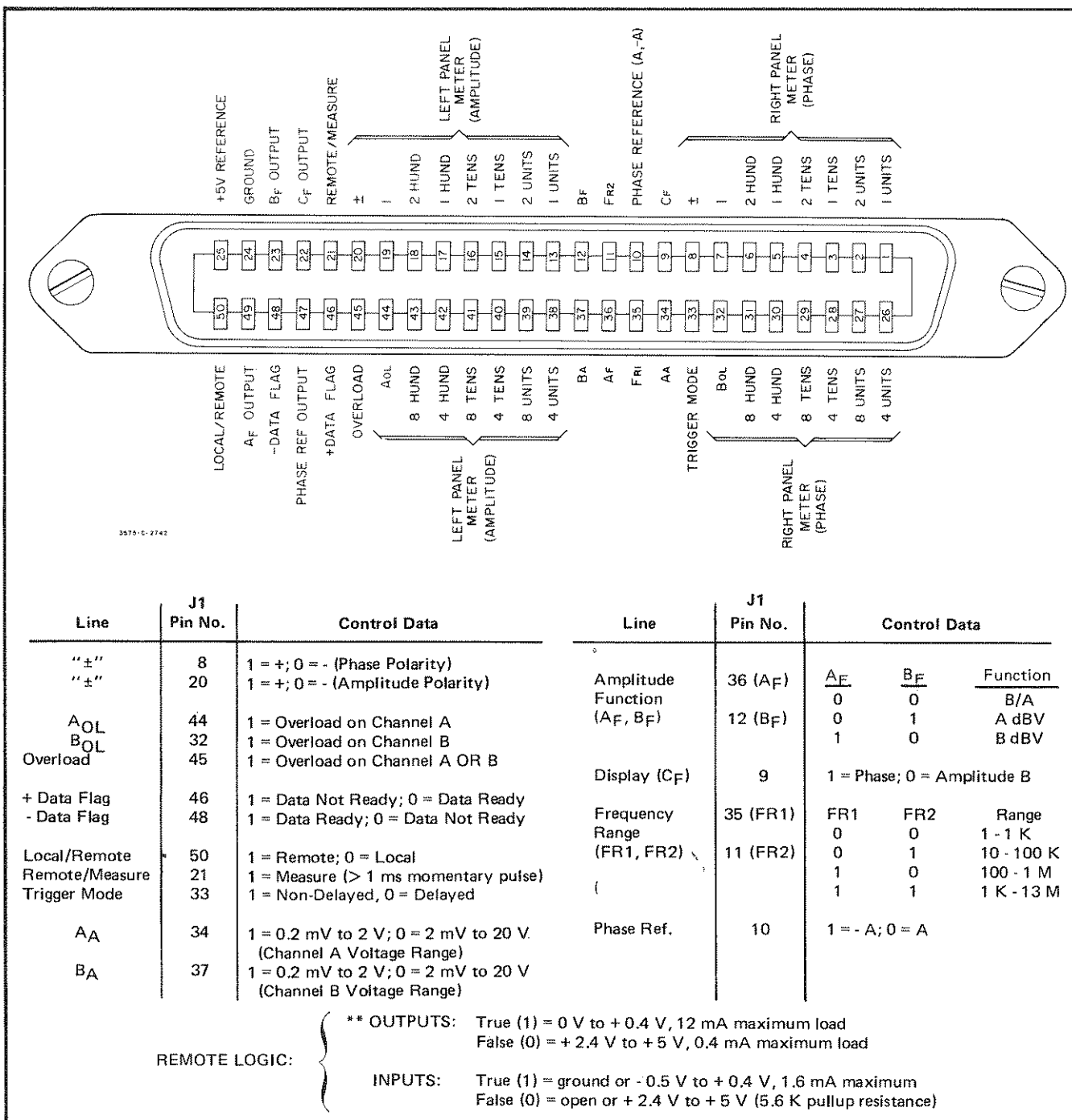

Figure 3-9. Remote Pin Connections.

* Cinch No. 57-30500-375
 ** Option 003 instruments use high-true logic for BCD outputs.

3-75. Local/Remote Control. Remote control operation is selected by applying a continuous ground (or -0.5 V to +0.4 V) to the Local/Remote control line (J1 pin 50). When ground is applied to the Local/Remote line, the following things take place within the 3575A:

- a. The front panel controls (except LINE switch) are disabled.
- b. The remote control lines are enabled.
- c. The internal sampling in both panel meters is disabled (external triggering must be used).
- d. The external trigger and flag timing circuits are enabled.
- e. The "Remote" (REM) annunciators on the panel meters illuminate.

3-76. Remote Control Lines. In the remote control mode, the 3575A Option 002 will accept parallel binary instructions applied to the remote control lines. Since internal storage is not provided, the control lines must be held at ground (or -0.5 V to +0.4 V) by the external controller whenever a "true" condition is required. When remote operation is selected without inputs to the remote control lines, the lines are held in a "false" condition by the internal logic circuitry. With all control lines false, the control settings are programmed as follows:

```

AMPLITUDE B/PHASE  AMPLITUDE B
Voltage Range ..... 2 mV to 20 V
                    (both channels)
FREQUENCY RANGE ..... 1 - 1 K
AMPLITUDE FUNCTION ..... B/A
PHASE REFERENCE ..... A
    
```

3-77. BCD Outputs. The 3575A Option 002 is equipped with separate BCD outputs for the two panel meters. These outputs provide parallel BCD information that corresponds with the respective panel meter readings. The BCD outputs each consist of three 8-4-2-1 BCD-coded digits, a single-line overrange ("1") digit and a single-line polarity indicator. Unlike the remote control lines, the BCD outputs are always enabled and can be used in the local or remote control mode.

3-78. Overload Outputs. There are three overload indicator lines available at pins 32, 44 and 45 of the Interface connector. The A₀₁ line (J1 pin 44) goes low when channel A is overloaded and the B₀₁ (J1 pin 32) goes low when channel B is overloaded. The third line, labeled "overload" (J1 pin 45), goes low when either or both channels are overloaded. Since the overload outputs are not stored functions, they will automatically return to the "false" condition (+5 V) when the overload is removed.

3-79. External Triggering and Flag Timing Sequence. As previously indicated the internal sampling in both panel meters is disabled when ground is applied to the Local/Remote control line. This means that external triggering must be used to obtain successive meter readings or BCD outputs in the remote control mode.

3-80. In the 3575A Option 002, the external triggering circuit operates in conjunction with the flag timing circuit to allow adequate settling time, trigger the panel meters and provide a "data ready" flag to the external controller. The timing sequence is initiated by an external trigger pulse which is applied to the Remote Measure line (J1 pin 21). The duration of the timing sequence depends on the condition of the Trigger Mode line (J1 pin 33) which permits selection of two modes of operation: the Delayed Mode and Non-Delayed Mode.

NOTE

The Remote Measure command must be delayed for at least 0.5 ms following any change that affects the programmed state of the instrument.

3-81. Delayed Mode. When the Trigger Mode line is held in a "false" condition (open or +2.4 V to +5 V), the timing sequence is as shown in Figure 3-10. In Figure 3-10, the Remote Measure line is pulled low at T₀ by the external controller. This initiates a variable delay period (determined by the Frequency Range setting) and sets the + and - Data Flags. At the end of the variable delay (T₁), a 600 ms delay is initiated and, at the same time, a 600 ms trigger pulse is applied to the panel meters. At the end of the 600 ms delay (T₂) both Data Flags are reset to indicate that data is ready.

3-82. The total time required to obtain a reading (T₀ to T₂) is equal to 600 ms plus the variable delay period determined by the Frequency Range setting. The approximate *total* delay times on each frequency range are as follows:

Frequency Range	Total Delay
1 - 1 K	33 sec.
10 - 100 K	4 sec.
100 - 1 M	1.1 sec.
1 K - 13 M	0.66 sec.

3-83. The purpose of the variable delay in the timing sequence is to allow time for the instrument to stabilize before a reading is taken. Since the times allotted by the variable delay are maximum, the instrument will often stabilize before the end of the delay period. This depends on the change in input parameters or control settings prior to the Remote/Measure pulse. In some applications such as swept measurements where readings are taken after slight changes in input parameters, it may be desirable to speed up the measurement process by omitting the variable time delay. This can be accomplished by holding the Trigger

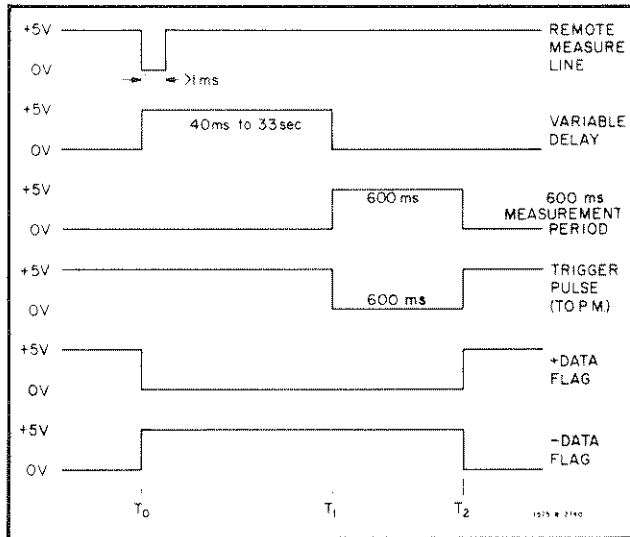

Figure 3-10. Flag Timing Delayed Mode.

Mode line in a "true" condition (gnd. or -0.5 V to $+0.4$ V). When the Trigger Mode line is grounded, the timing sequence is in the Non-Delayed Mode which operates as shown in Figure 3-11.

3-84. Non-Delayed Mode. In Figure 3-11, the Remote Measure line is pulled low at T_0 by the external controller. This immediately initiates the 600 ms delay, triggers the panel meters and sets the + and - Data Flags. At the end of the 600 ms delay (T_1), the Data Flags are reset to indicate that a reading has been taken.

3-85. Remote Measure Rate. As indicated in preceding paragraphs, the time required to obtain a reading depends on the selected mode of operation. In the Delayed Mode, the time varies from 0.1 second to 33 seconds as a function of the Frequency Range setting. In the Non-Delayed Mode, the time is fixed at approximately 600 ms. In order to obtain successive readings at a fixed rate, the time between Remote Measure pulses must be greater than the total delay period. For example, in the Non-Delayed Mode the 600 ms delay period allows a maximum of 1.6 readings per second.

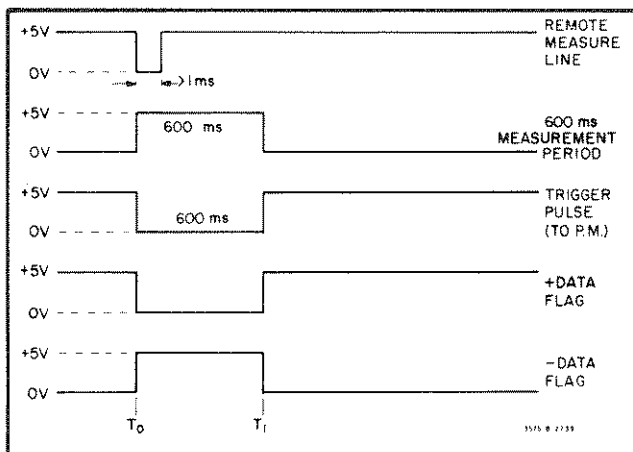

Figure 3-11. Flag Timing Non-Delayed Mode.

In the Delayed Mode, 0.66 sec. allows 1.5 readings per second, 1.1 sec. allows 54 readings per minute, 4 sec. allows 15 readings per minute and 33 seconds allows 1.8 readings per minute. In all cases, the Remote Measure pulse width must be greater than 1 ms and less than the total delay period.

3-86. Optional Control Scheme. For some applications, it is convenient to control the instrument from the front panel and, at the same time, use external triggering and the flag timing functions. To allow this, a jumper is provided on the Interface Assembly (A16B, Schematic No. 9). With the jumper connected between points 1 and 2 (normal), grounding the Local/Remote control line disables the front panel controls, enables the remote control lines and enables the external trigger and flag timing circuits. With the jumper connected between points 1 and 3, the front panel controls are enabled and the remote control lines are disabled regardless of the condition of the Local/Remote control line. The external triggering and flag timing functions can then be used along with the front panel controls by grounding the Local/Remote control line.

3-87. USING A PRINTER.

3-88. The 3575A Option 002 output lines are compatible with -hp- Digital Recorder Models 5050B and 5055A. These printers can be connected directly to the 3575A Interface connector using the -hp- 562A-16C printer cable. Complete interfacing data is presented in Section II, Paragraph 2-29.

3-89. Triggering.

3-90. When using a printer, it is necessary to supply a ground-true (>1 ms) Remote Measure command to the 3575A each time a printout is required (see Paragraphs 2-30 and 3-80). The Remote Measure command sets the Data Flags and initiates the timing cycle within the 3575A. The printer receives a "print" command when the Data Flags are reset at the end of the timing cycle. Unless special arrangements have been made to ground the Trigger Mode line, the 3575A will remain in the Delayed mode and the "print" command will be transmitted at the end of the delay period. The delay period varies from approximately 33 seconds to 0.66 second as a function of the Frequency Range setting. If the Trigger Mode line is grounded, the "print" command will be transmitted approximately 600 ms after the leading edge of the Remote Measure pulse.

3-91. Printout.

3-92. The -hp- Models 5050B and 5055A Digital Recorders provide a ten-column printout. The printer columns are numbered from right to left and the 3575A output data is printed as follows:

3-93. Right-Hand Panel Meter. The “units”, “tens” and “hundreds” digits for the right-hand (phase) panel meter are printed in columns 1, 2 and 3, respectively. The overrange (“1”) digit, polarity sign (“±”) and B overload (B_{OL}) outputs are printed in decimal-coded form in column 4. The coding for column 4 is listed in Table 3-4.

Table 3-4. Printer Column 4 Coding.

Column 4 Printout	“1” Overrange	“±” Polarity	B Overload
0	0	-	No
1	1	-	No
2	0	+	No
3	1	+	No
4	0	-	Yes
5	1	-	Yes
6	0	+	Yes
7	1	+	Yes

3-94. Unused Columns. When a printer is connected directly to the 3575A using the -hp- 562A-16C printer cable, the eight lines that control printer columns 5 and 6 are held at +5 Vdc (false) by pullups within the 3575A. For this reason, columns 5 and 6 should always be zero.

3-95. Left-Hand Panel Meter. The “units”, “tens” and “hundreds” digits for the left-hand panel meter are printed in columns 7, 8 and 9 respectively. The overrange (“1”) digit, polarity sign (“±”), A overload (A_{OL}) and “overload” (A OR B) outputs are printed in decimal-coded form in column 10. The coding for column 10 is listed in Table 3-5.

Table 3-5. Printer Column 10 Coding.

Column 10 Printout**	“1” Overrange	“±” Polarity	A Overload	A OR B Overload
0	0	-	No	No
1	1	-	No	No
2	0	+	No	No
3	1	+	No	No
8	0	-	No	Yes
9	1	-	No	Yes
+	0	+	No	Yes
-	1	+	No	Yes
V	0	-	Yes	Yes
A	1	-	Yes	Yes
Ω	0	+	Yes	Yes
*	1	+	Yes	Yes

** Digits 4, 5, 6 and 7 represent illegal states.

